

**HIWIN<sup>®</sup>**



# STAGE:Single Axis

Maintenance Manual

## Revision History

The version of the manual is also indicated on the bottom of the front cover.

MM07UE01- 20 06

Release Month

Release Year

Release Date	Version	Applicable Product	Revision Contents
Jun. 30 <sup>th</sup> , 2020	1.1	Single Axis Control System	Initial Issue

# Table of Contents

1.	HIWIN STAGE Notification Before Usage.....	1-1
1.1	Caution Notice.....	1-2
1.2	HIWIN STAGE Operation Environment.....	1-3
2.	HIWIN STAGE Maintenance Tool .....	2-1
2.1	Maintenance Tool .....	2-2
3.	HIWIN STAGE Structure .....	3-1
3.1	HIWIN STAGE Structure .....	3-2
4.	HIWIN STAGE Maintenance Item .....	4-1
4.1	Blocks and Guideways .....	4-2
5.	HIWIN Lubrication and Maintenance Procedure .....	5-1
5.1	Stage Lubrication Flow Chart .....	5-2
5.2	Stage Lubrication Procedure .....	5-3
5.2.1	Judge Whether the Block is Full of Grease .....	5-4
5.2.2	Distinguish Whether the Grease is Over Injected .....	5-5
5.2.3	Test Run the Stage .....	5-6
5.2.4	Clean the Overflows on Guideway and Blocks .....	5-7
5.3	Stage Lubrication and Maintenance Schedule .....	5-8
6.	Stator Cleaning and Caution Notice .....	6-1
6.1	Caution Notice.....	6-2
6.1.1	LMS Series .....	6-3
6.1.2	LMT Series .....	6-4
6.1.3	LMC Series.....	6-5
7.	Cleaning and Maintenance Points for Optical Encoder .....	7-1
7.1	Clean the Optical Encoder .....	7-2
7.2	Read Head (Encoder) Adjustment.....	7-3
7.3	Optical Scale Index Adjustment.....	7-4

(This page is intentionally left blank.)

# 1. HIWIN STAGE Notification Before Usage

---

1.1	Caution Notice.....	1-2
1.2	HIWIN STAGE Operation Environment.....	1-2

## 1.1 Caution Notice

Before shipping, Hiwin stage is packed by special wooden crate and fixed by red bracket (as Fig.1 and Fig.2 shown) to avoid any damage during delivery. When receiving the stage, please confirm whether there is any damage on the bracket; moreover, the bracket needs to be removed before testing the stage.

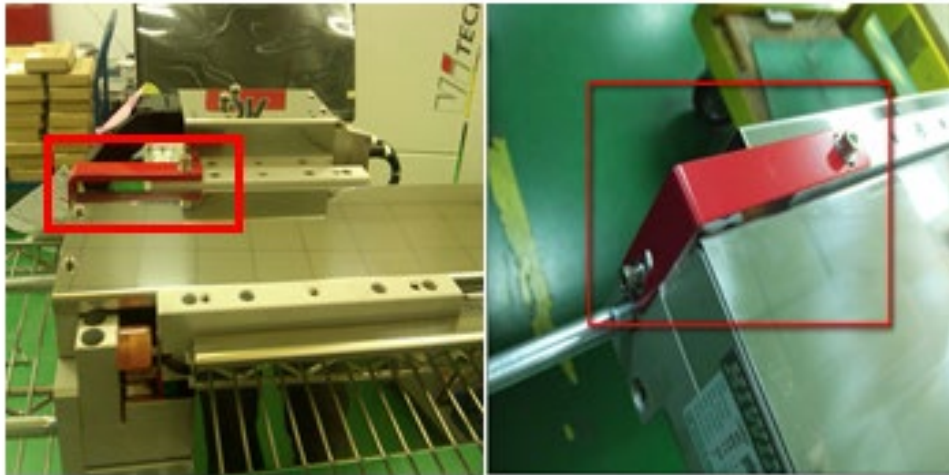

Fig.1

Fig.2

- (1) It is suggested to regularly maintain and lubricate the guideway every 3 months, or when the stage runs over 100km.
- (2) If the Stage is equipped with optical scale, then it is suggested to clean the scale with IPA regularly to avoid particle issue, which may affect the function.  
(The usage of Ethanol or other solvent is prohibited.)
- (3) The stator on HIWIN Stage is permanent magnet modules. To ensure the function, please prevent any iron-made foreign objects from falling and adsorbing on the stator to ensure the function and operation. (E.g.: Blade, Wrench.)
- (4) Before supplying the power from drive, please ensure that the AC power cable, motor cable, encoder signal cable and communication cable are all connected correctly and firmly. To prevent electric shock or damage on electronic components, unplugging the connector while power on is prohibited.
- (5) Please be noted that people shouldn't stand at both sides of the stage running direction. Also, it is strictly forbidden for people to approach the running area of the stage to avoid injuring during operation.
- (6) If the HIWIN STAGE is used with HIWIN drive, Please refer to drive user manual. If you encounter any problem when setting up please contact Service team by email ([service@hiwinmikro.tw](mailto:service@hiwinmikro.tw)) or Tel number (+886-4-2355-0110 Ext.9310).

## 1.2 HIWIN STAGE Operation Environment

- (1) Temperature: 0°C -50°C
- (2) Humidity: < 80% RH ( non-condensing )
- (3) IP50 rating. No corrosive solvent usage or strong magnetic interference.
- (4) Plant power grounding cable need to meet international requirements.

(This page is intentionally left blank.)



## 2. HIWIN STAGE Maintenance Tool

---

2.1	Maintenance Tool .....	2-2
-----	------------------------	-----

## 2.1 Maintenance Tool

(a) Grease



(b) Wipers



(c) IPA



(d) Grease gun



(e) Ethanol



(f) Wrench set



## 3. HIWIN STAGE Structure

---

3.1	HIWIN STAGE Structure .....	3-1
-----	-----------------------------	-----

### 3.1 HIWIN STAGE Structure

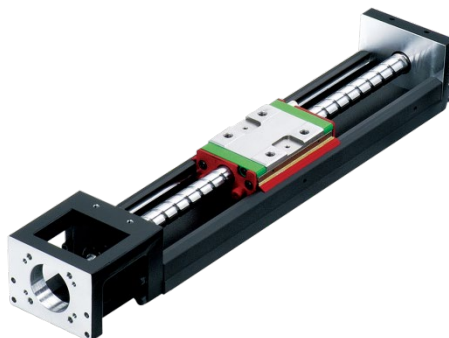

## 4. HIWIN STAGE Maintenance Item

---

4.1	Blocks and Guideways.....	4-2
-----	---------------------------	-----

## 4.1 Blocks and Guideways

### (1) Blocks

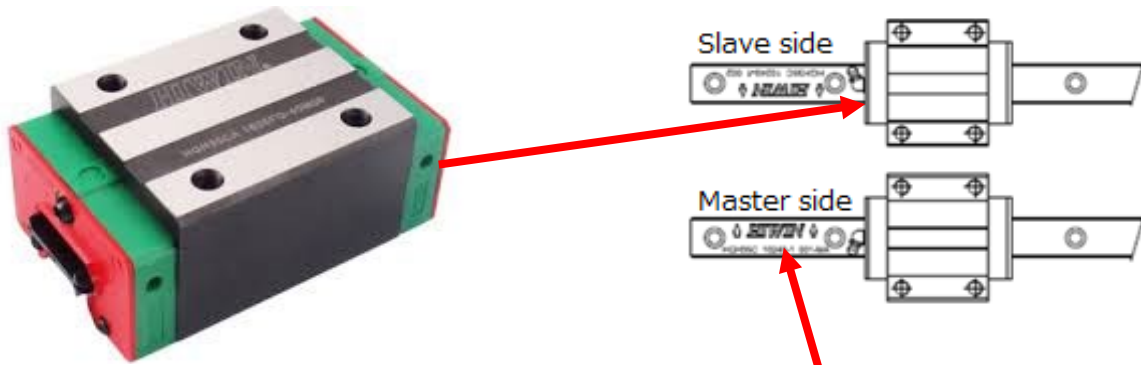

(Fig. 3)

### (2) Guideways



(Fig. 4)

## 5. HIWIN Lubrication and Maintenance Procedure

---

5.1	Stage Lubrication Flow Chart.....	5-2
5.2	Stage Lubrication Procedure.....	5-3
5.2.1	Judge Whether the Block is Full of Grease .....	5-4
5.2.2	Distinguish Whether the Grease is Over Injected.....	5-5
5.2.3	Test Run the Stage.....	5-6
5.2.4	Clean the Overflows on Guideway and Blocks.....	5-7
5.3	Stage Lubrication and Maintenance Schedule.....	5-8

### 5.1 Stage Lubrication Flow Chart

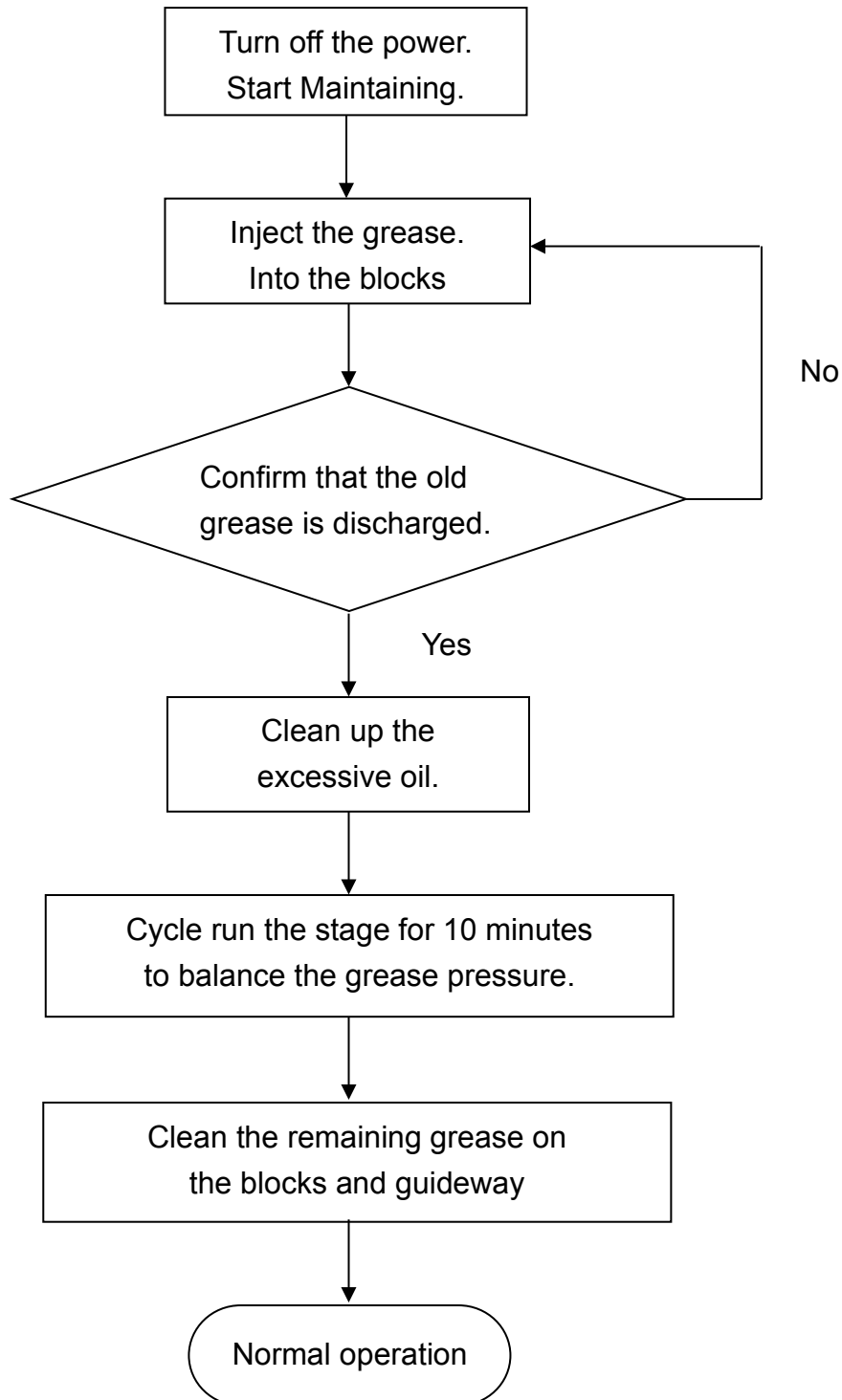



## 5.2 Stage Lubrication Procedure

Since the roller part can't be seen after installing the cross roller, if the stage has no friction sound or jitter problem, then there is no need to disassemble the stage for maintenance. Only clean the dirt and stain on surface and apply with antirust oil.

- (1) Use wiper to clean up the grease dirt and stain on the surface.
- (2) Move the forcer to the stopper side.
- (3) Fill-in the grease into grease gun.
- (4) Aim the grease gun to the grease nozzle. And then inject the grease into blocks.
- (5) Move the stator back and forth to lead the grease into balls in roller part.
- (6) Clean the excessive grease, in case any pollution on the stage or optical scales.

(a) Fill-in the grease



(b) Aim the grease gun to nozzle

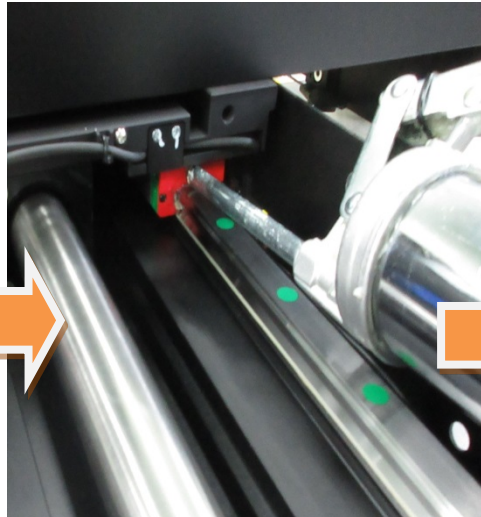

(c) Lubricate

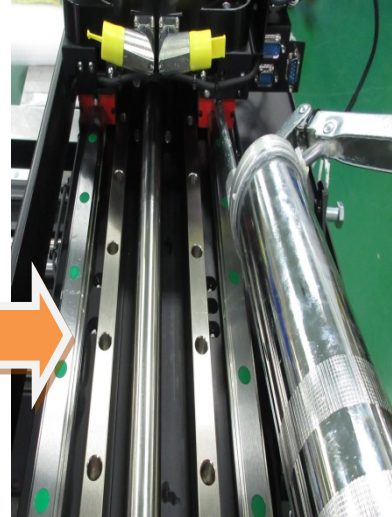

### 5.2.1 Judge Whether the Block is Full of Grease

- (1) Constantly inject grease through the grease nozzle (Fig. 5).
- (2) Observe whether there is any grease spilling from the scraper. If the grease has spilled, please stop injecting grease (Fig. 6).

Please judge whether the block is full of grease by following comparison figuration. Excessive grease may cause quality issue.

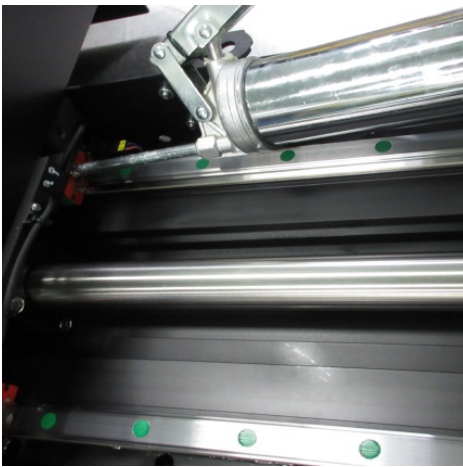

Fig. 5

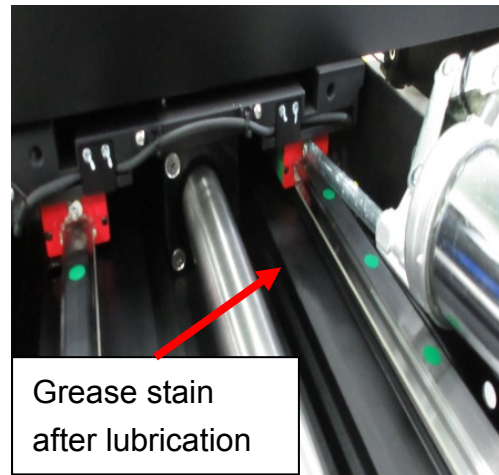

Fig. 6

## 5.2.2 Distinguish Whether the Grease is Over Injected

(1) Please refer to following figurations (Fig. 7-8) to compare and distinguish whether the grease is over Injected. Excessive grease may cause quality issue.

(2) Considering the optical scale position, it may be polluted by excessive grease. (Fig. 9-10)

Note: Please notice that the cleaning after greasing is important. Including normal type and clean-room type, the grease would become grease stain or get deteriorated after using a period of time, which may cause following issue.

a. Grease stain on optical scale may cause encoder feedback error.

b. Grease stain dripped on product, may cause quality issue.

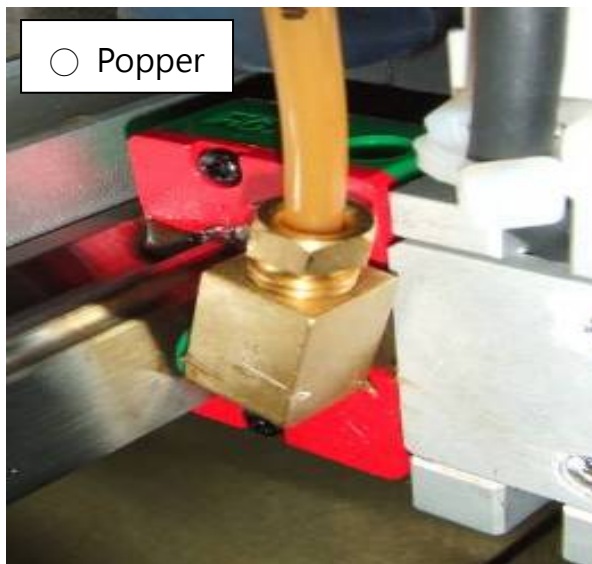

Fig 7



Fig 8

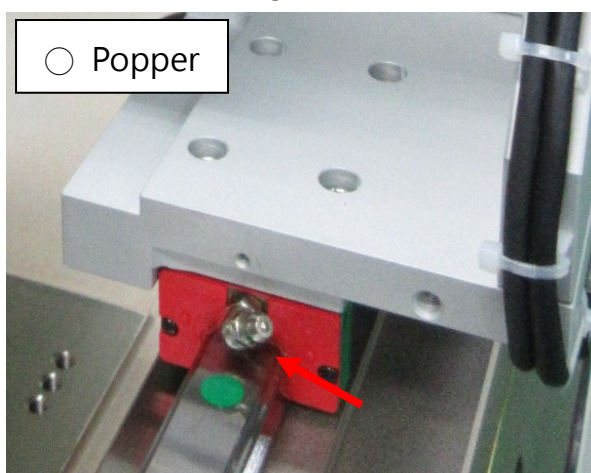

Fig 9

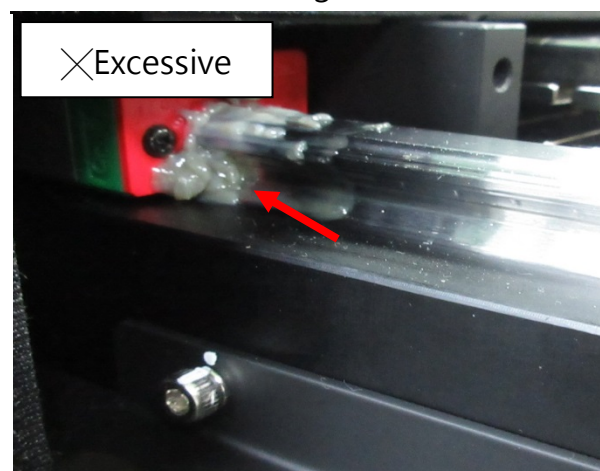

Fig 10

### 5.2.3 Test Run the Stage

After lubricating, please continue to cycle run the stage for over 10 minutes, which could balance the grease inside the blocks and balls. This could also release the saturation pressure and avoid the grease continuing to overflow and accumulating between the block and the guideway.

## 5.2.4 Clean the Overflows on Guideway and Blocks

Stage can start motion after cleaning the excessive grease.

(a) Grease accumulation

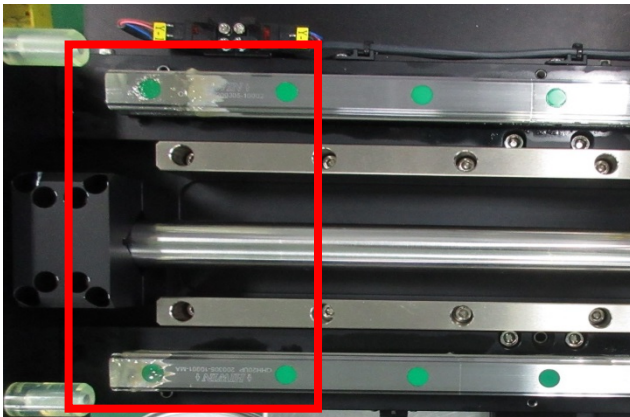

(b) Clean with wipers

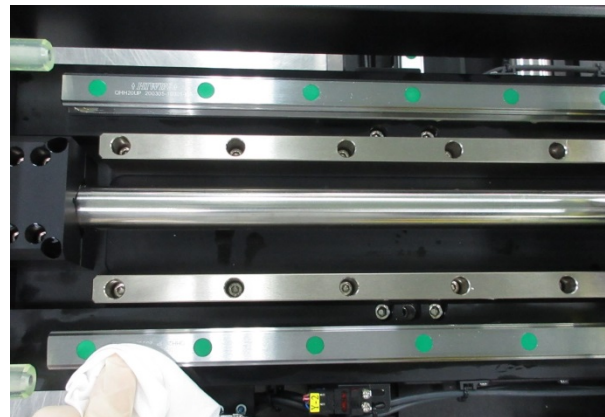

(c) Guideway after cleaning

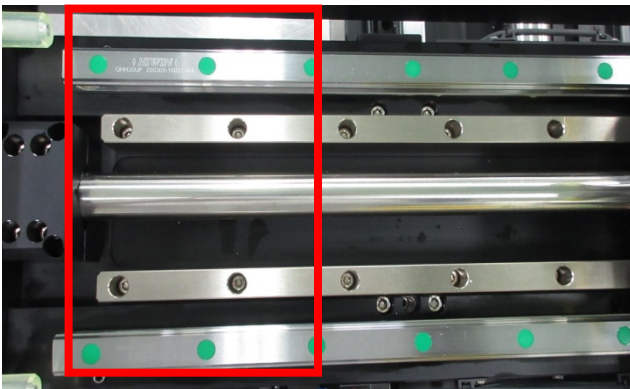

(d) Block after cleaning

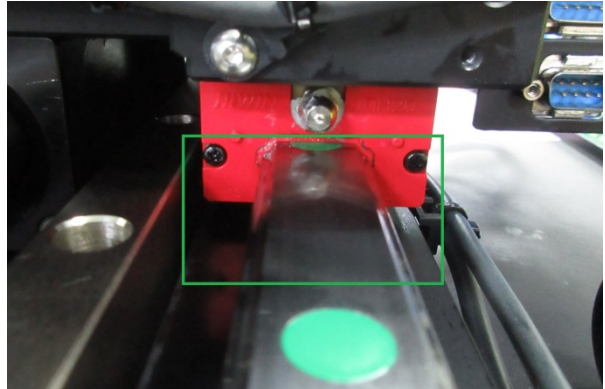

## 5.3 Stage Lubrication and Maintenance Schedule

- (1) Using greasing which viscosity is around 32-150cst.
- (2) It is suggested to regularly maintain and lubricate the guideway every 3 months, or when the stage runs over 100km. If guideway is not properly lubricated, the friction of the rolling part will increase. After long-term usage, this is the main reason why the life time of guideway will be shorter.
- (3) Below is the function of grease:
  - a. Decrease the friction, prevent overheating and lower the abrasion.
  - b. After lubricating, there will grease film between the rolling parts, which could extend the fatigue life.
  - c. Prevent parts getting rusting.

## 6. Stator Cleaning and Caution Notice

---

6.1	Caution Notice.....	6-2
6.1.1	LMS Series.....	6-3
6.1.2	LMT Series.....	6-4
6.1.3	LMC Series.....	6-5

## 6.1 Caution Notice

- (1) There is strong magnetic force between LMS motor's forcer and stators. When cleaning the motor, the forcer and stator can't be too close to each other.
- (2) LMT motor is rod-shaped linear motor. DO NOT attach with magnetic object or any items which could be easily magnetized.
- (3) The LMC stator is U-shaped module with permanent magnets in the middle. DO NOT attach with magnetic or properties of magnetization items. (E.g.: Screws, spacer.) The space in U-shaped tube is limit. Thus, if any foreign material gets stuck, it may not be able to reach out. Please apply Ethanol on wiper and clean up the surface, if there is any stain on surface.

### Note:

- a. If the stage is used under unideal environment, it should be aware of the cleaning on stators. Also, it is suggested to regularly maintain every 3 month.
- b. Stators and forcers (iron materials) can make powerful suction, which would hurt fingers and palms seriously. Don't let magnetic items get too close to avoid magnet attract. (E.g.: Knife, tools.)
- c. LMC stator is not suitable on the following maintenance procedure. If the stator has been attracted with each other, please contact HIWIN staff to assist it.



### 6.1.1 LMS Series

(a) Stain and Dirt on Stator

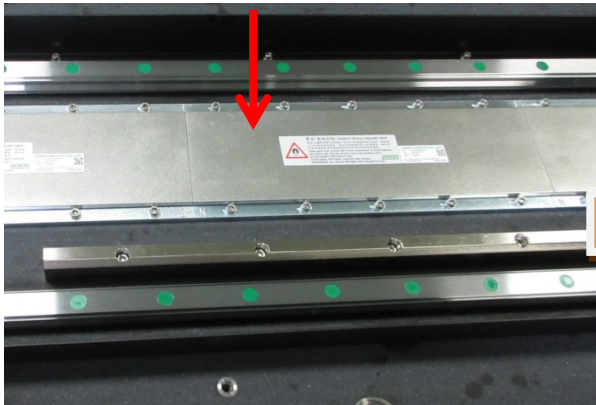

(b) Clean with wiper and Ethanol

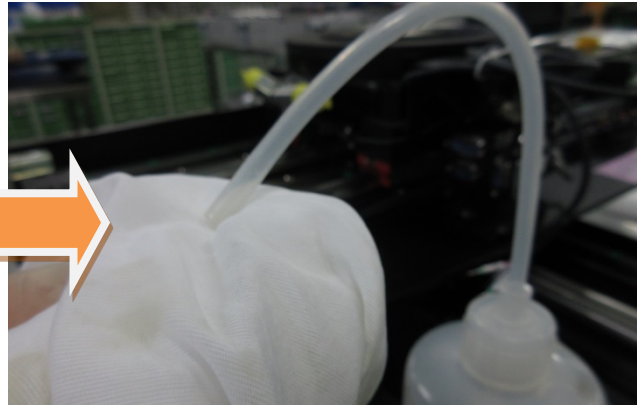

(c) Since the stator is adsorptive, please follow below direction to wipe the stators, and then clean up the dirt from the edge of the stators.

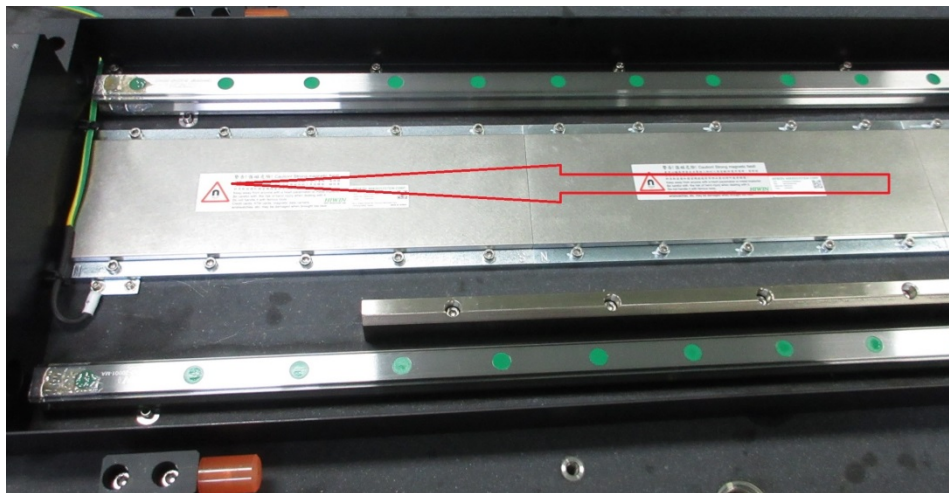

### 6.1.2 LMT Series

(a) Stain and Dirt on LMT

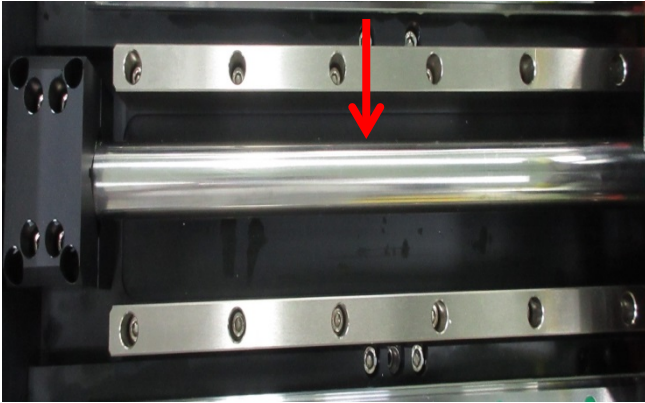

(b) Clean with wiper and Ethanol

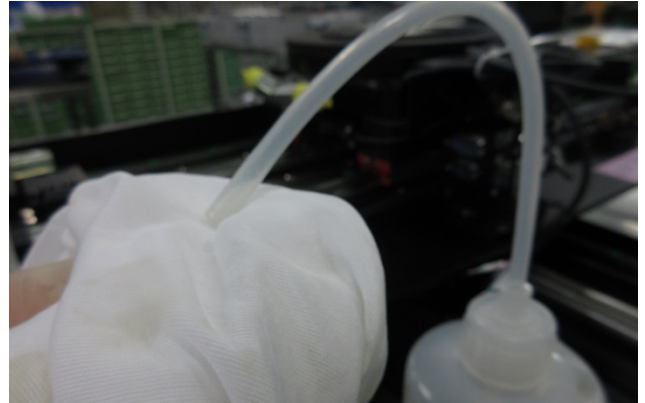

(c) Follow below direction to wipe the stators.

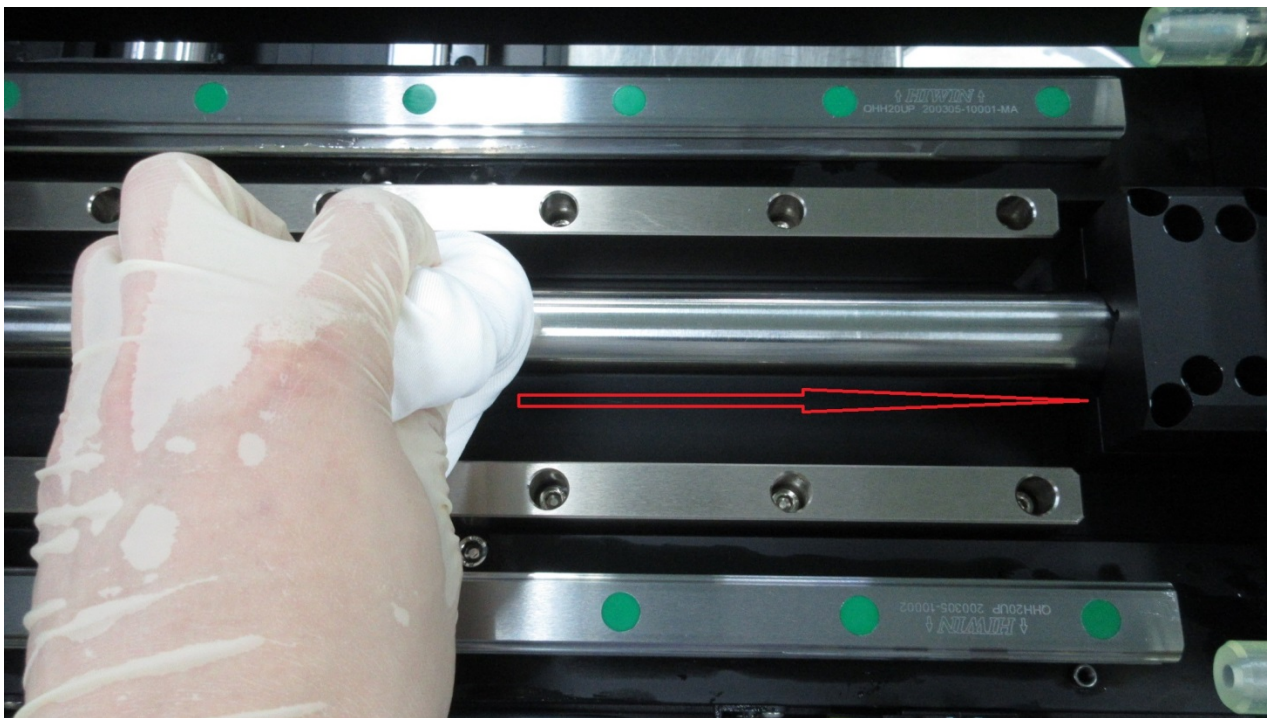

### 6.1.3 LMC Series

LMC stator is not suitable of following maintenance procedure.

If the stator has been attracted, please contact HIWIN service team to assist with the issue.

(1) Please notice that when operating LMC motor, the iron-made materials may have magnet attracted problem. Don't let magnetic items get too close. (E.g. Screws, spacers, Wrench.)

Please clean up the dirt on the surface with wiper and Ethanol.

Note: The space in U-shaped tube is limit. It is possible that the foreign material can't be reached out.



(This page is intentionally left blank.)

## 7. Cleaning and Maintenance Points for Optical Encoder

---

7.1	Clean the Optical Encoder .....	7-2
7.2	Optical Scale Read head Adjustment.....	7-3
7.3	Optical Scale Index Adjustment.....	7-4

## 7.1 Clean the Optical Encoder

※If the stage is used with Renishaw optical scale, please notice the surface. Do not scratch it.

- (1) When operating linear motor in unideal working environment, the grease and particle may attach to scales, which would cause encoder feedback error. As Fig. 11 shown, the golden part is optical scale. There will be Renishaw logo on both side of the scale.



Fig. 11

- (2) It is suggested to maintain the optical scale every 3 month.
- (3) Please apply IPA on wiper for cleaning. Do not apply the IPA on the scale directly.
  - ※Do not use Ethanol or any other solvent to clean up optical scale.

(a) Dirt on scale

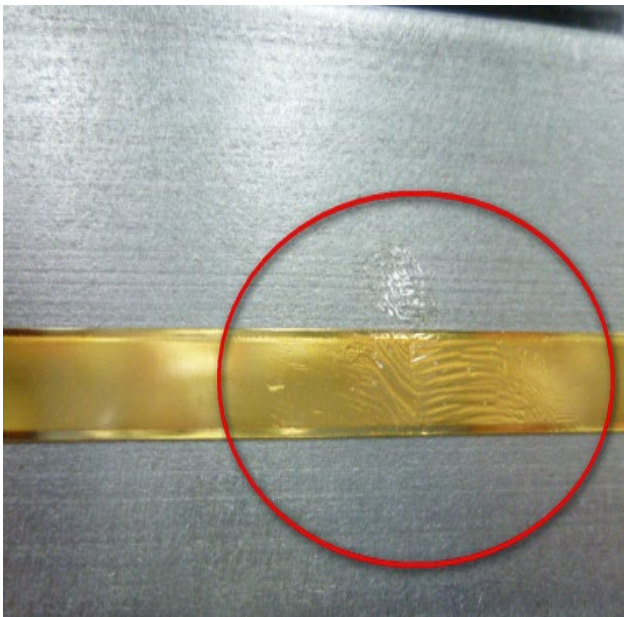

(b) Use wiper and IPA to clean up

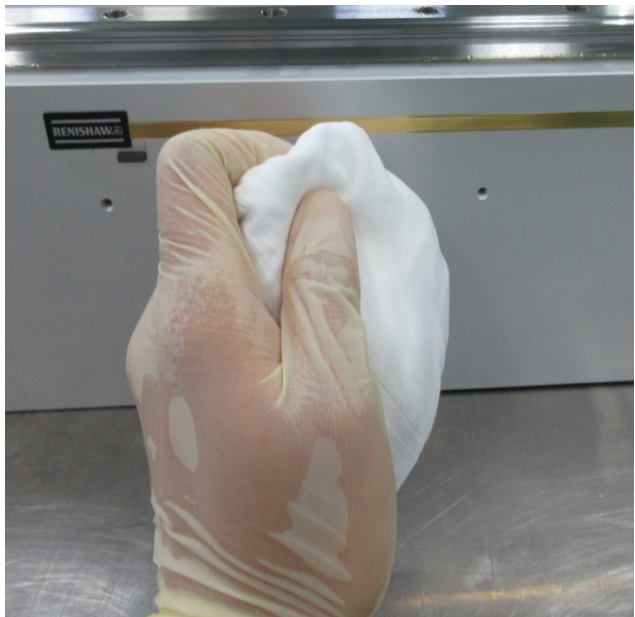

## 7.2 Read Head (Encoder) Adjustment

※The read head (encoder) signal is inspected before shipping. If any adjustment or replacement is required, it is recommended to contact service team. Although there is SOP for reference, it is still suggested to feedback the issue and to confirm the details with service team.

Caution Notice of adjusting optical scale:

- (1) Ensure that drive power is turned off. Please only supply control power from drive to confirm encoder signal.
- (2) Move any movable part in each axis to appropriate position (the place which is suitable for operation).
- (3) Make sure that read head's LED shows green in whole stroke. If not, use the attached blue spacer to adjust.
  - ※ Renishaw encoder gap is  $0.8 \pm 0.15$ mm.

(a) Green light blink in the whole stroke



(b) Renishaw encoder gap is  $0.8 \pm 0.15$ mm



(c) Blue spacer attached with read head



### 7.3 Optical Scale Index Adjustment

The LED in read head should blink in red when the motor is passing the index (Fig. 12). If not, please adjust with small Phillips screwdriver (Fig. 13).

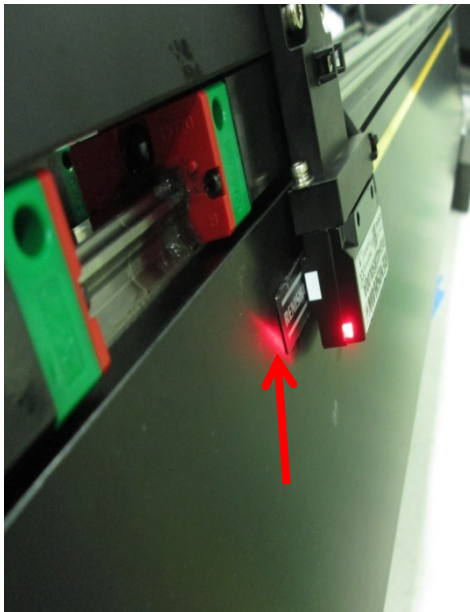
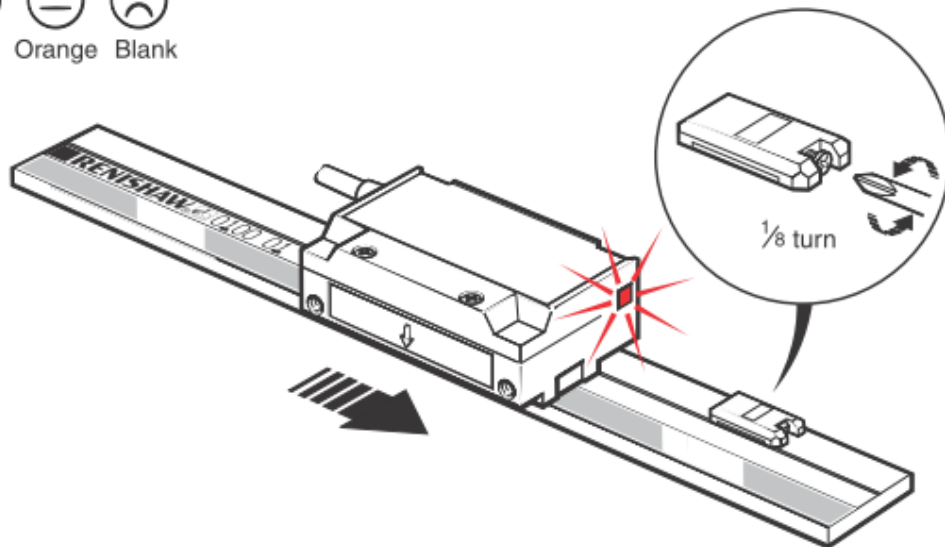

Fig. 12



Fig. 13

Readhead set-up LED flash during reference mark traverse only



Adjustment Figuration